

玄關及電視牆平面圖

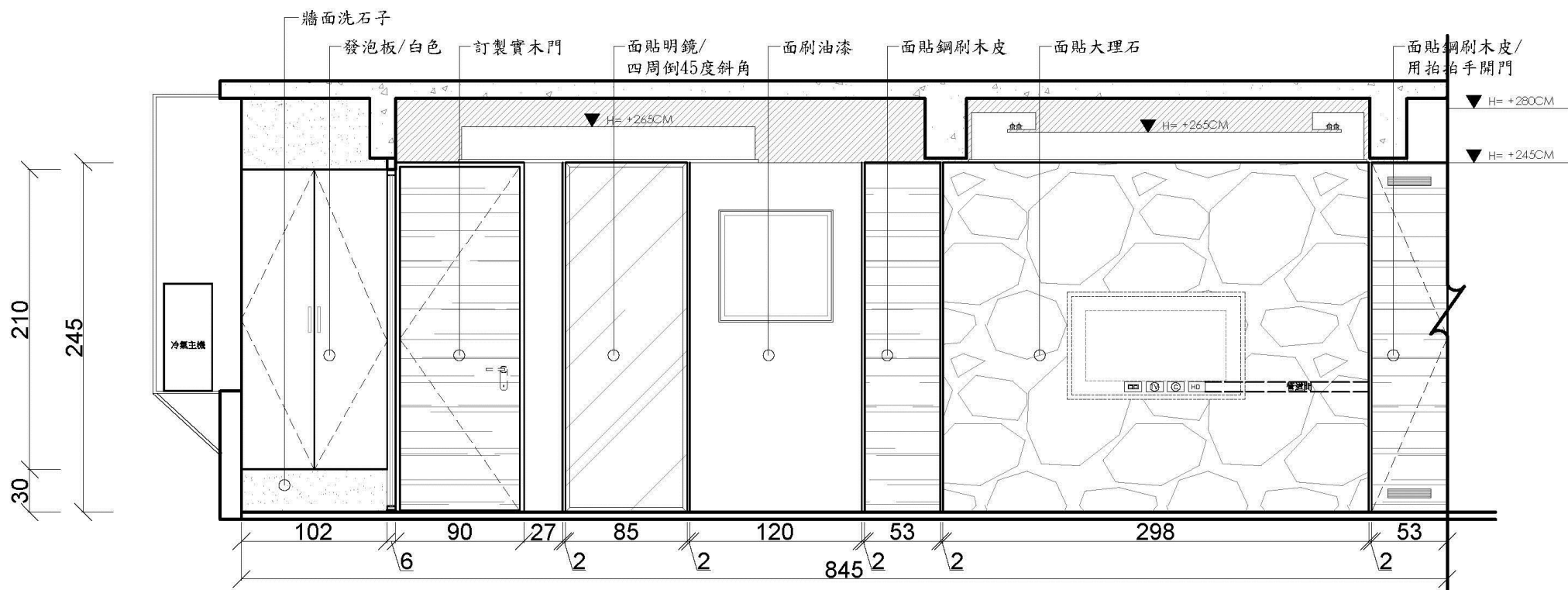

玄關及電視牆立面施工圖

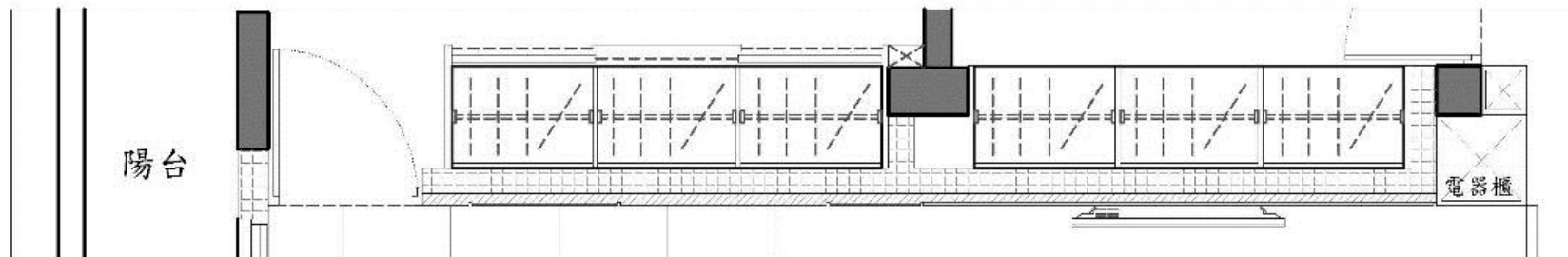

玄關及電視牆平面圖

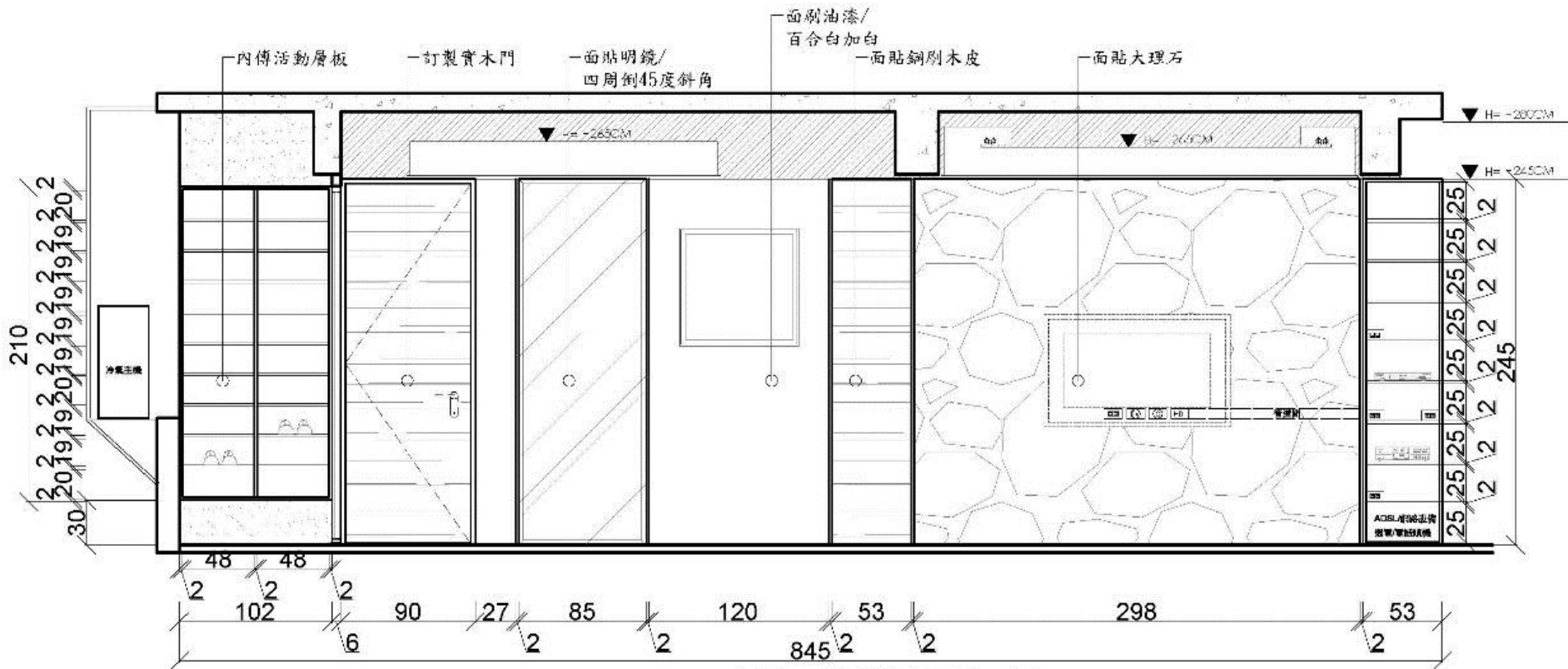

玄關及電視牆立面施工圖

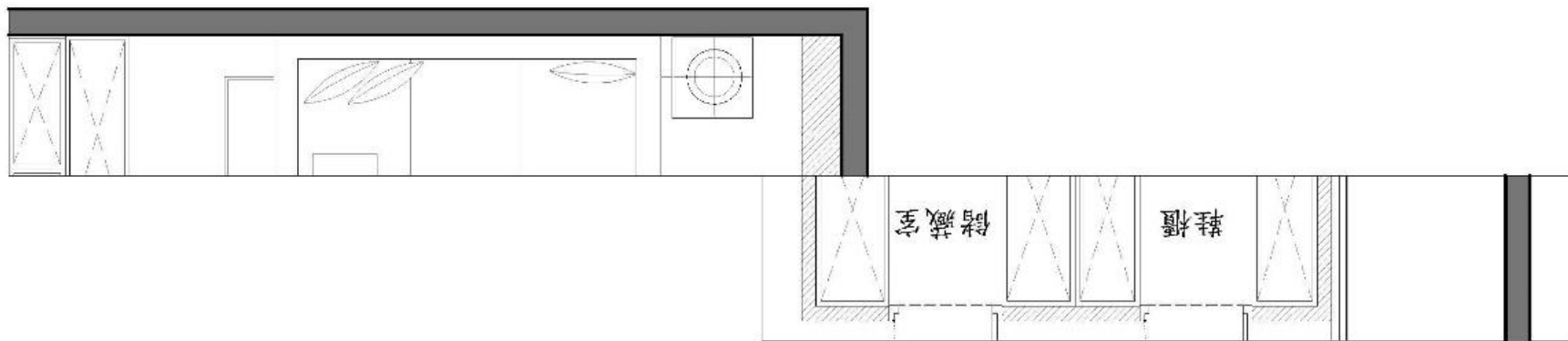

玄關及沙發背牆平面圖

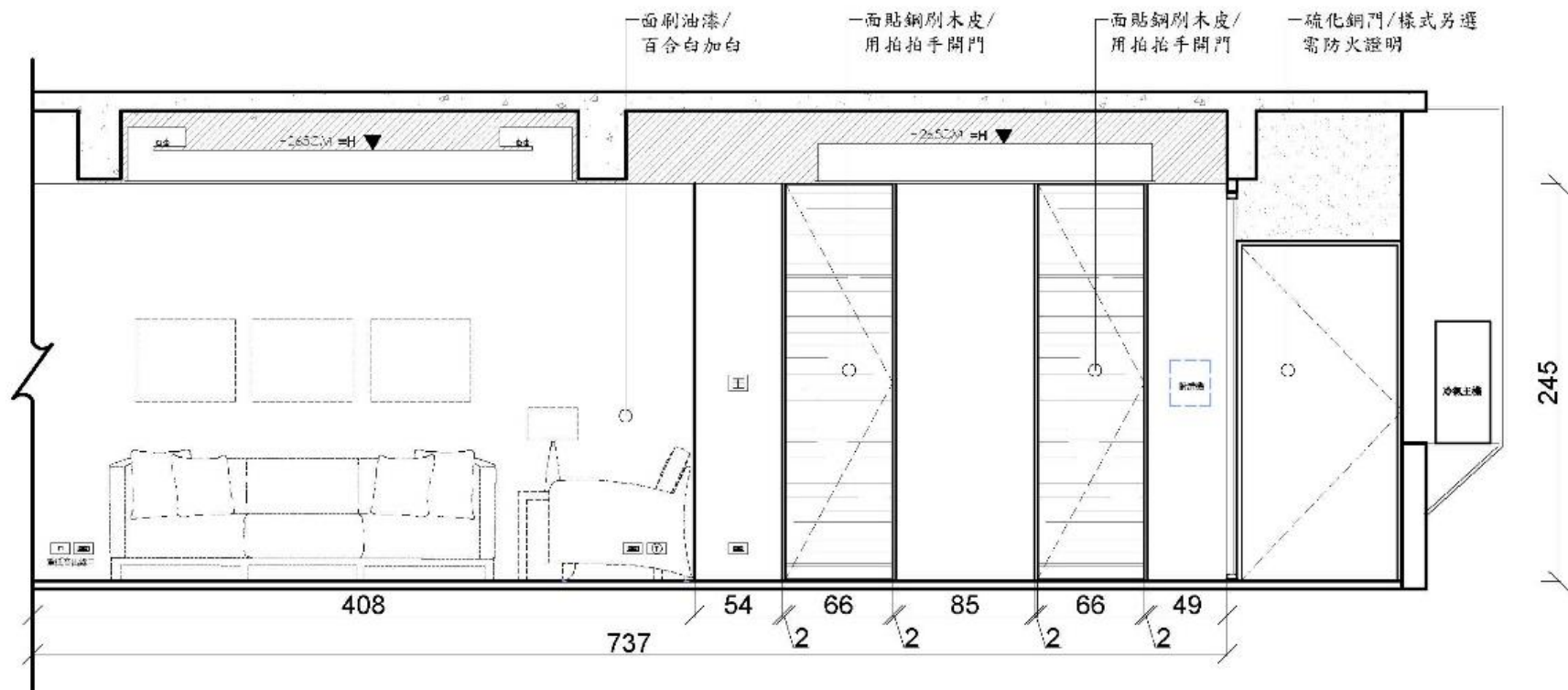

玄關及沙發背牆立面施工圖

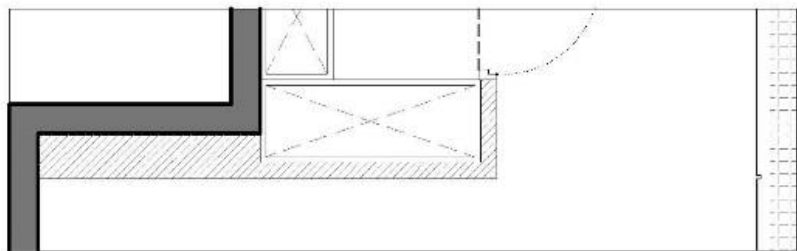

客廳左側平面圖

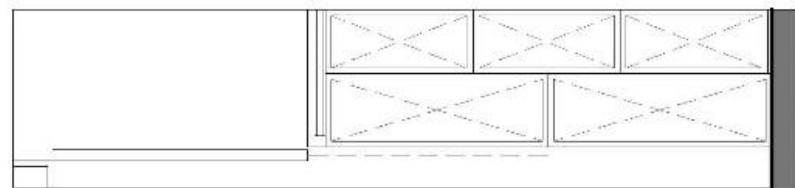

客廳右側平面圖

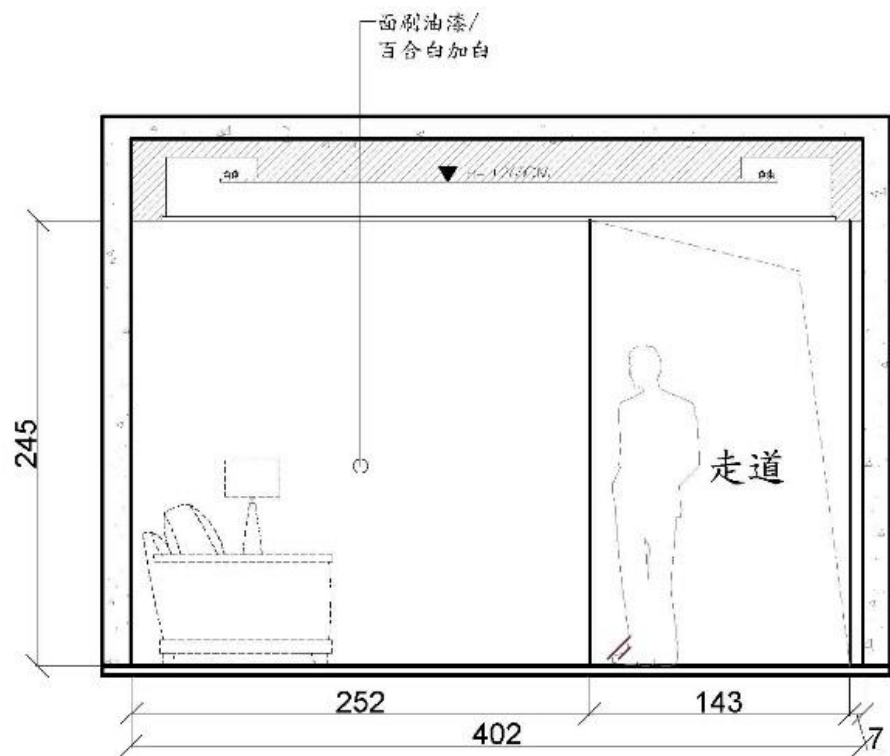

客廳左側立面施工圖

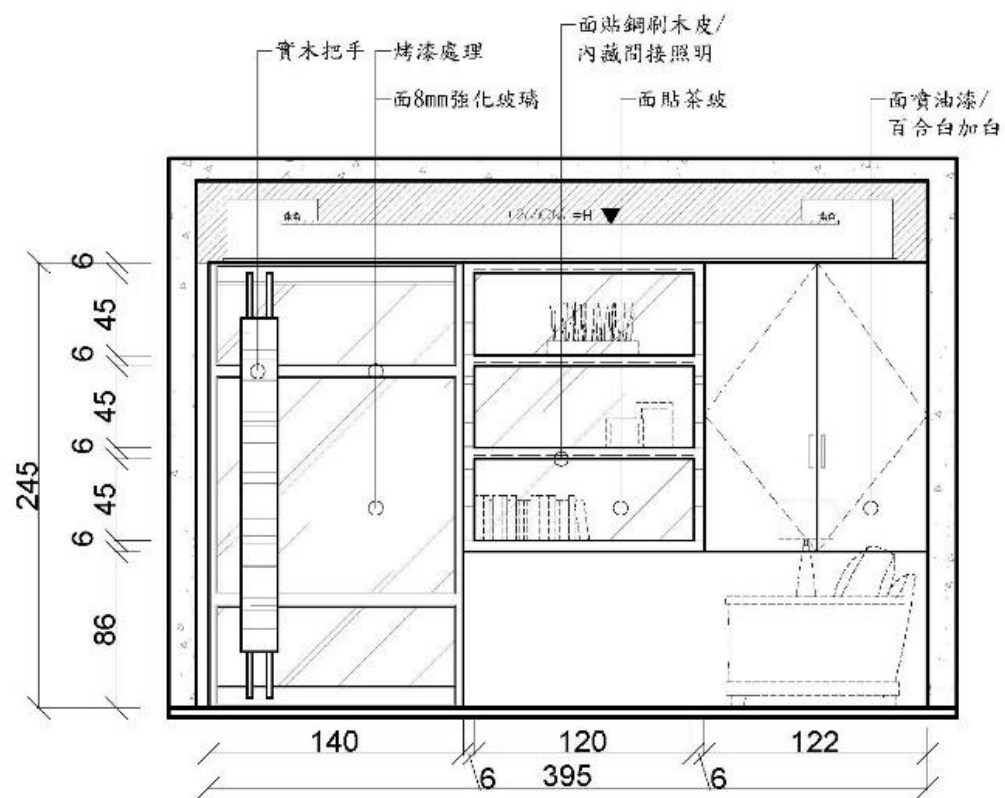

客廳右側立面施工圖

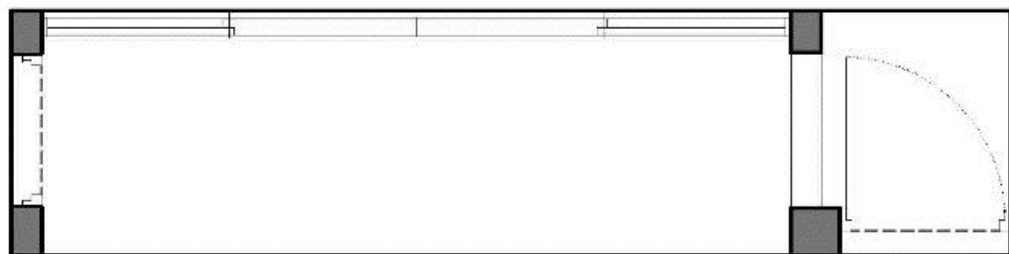

餐廳/戶外平台平面圖

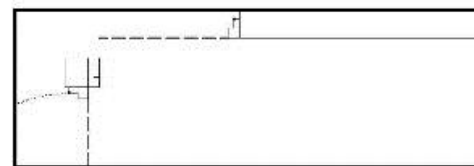

餐廳/浴廁平面圖

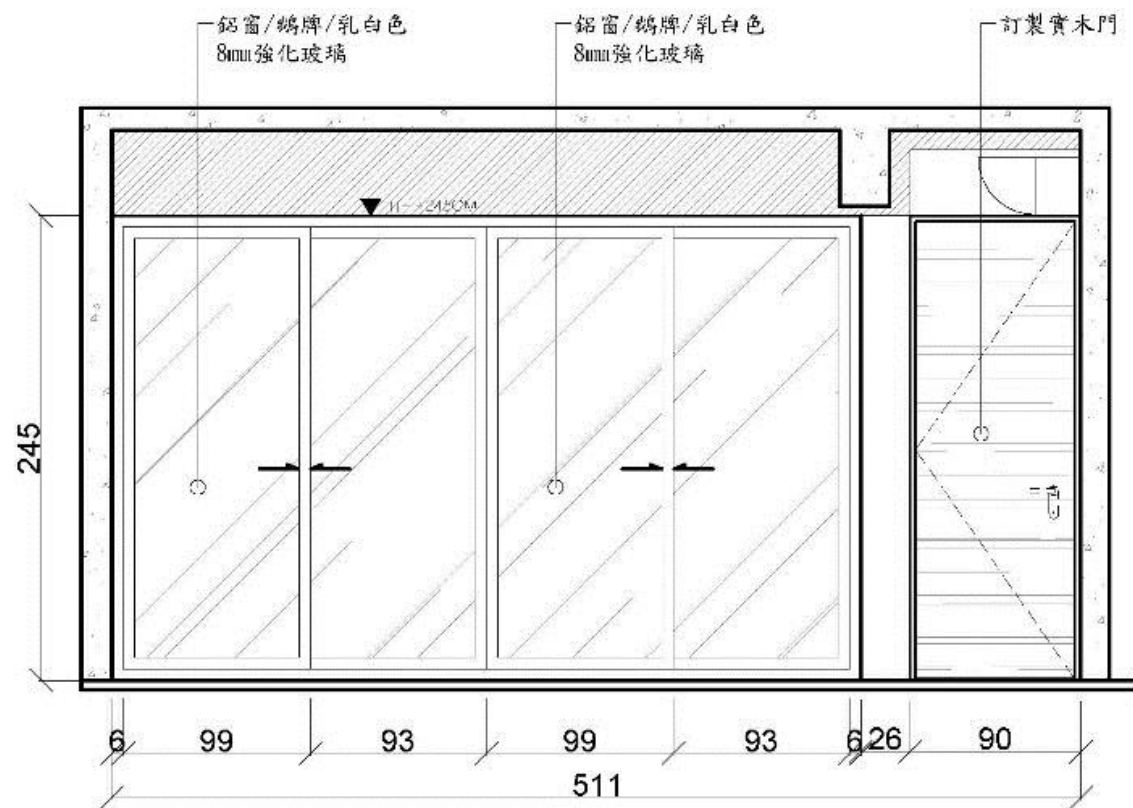

餐廳/戶外平台立面施工圖

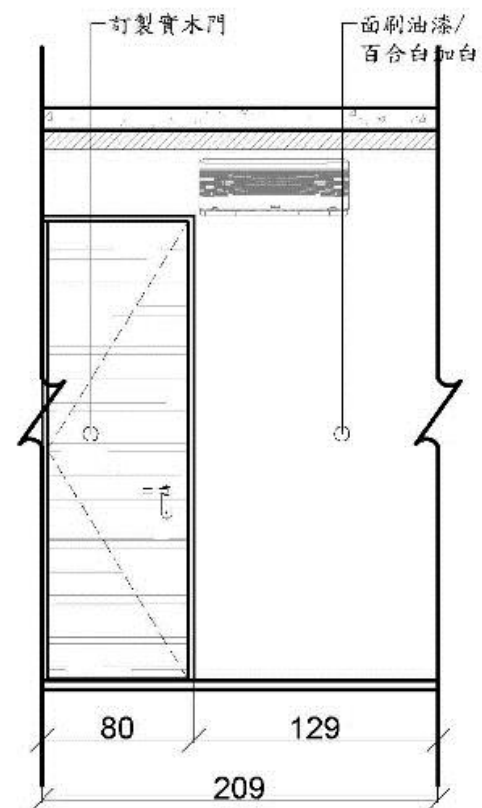

餐廳/浴廁立面施工圖

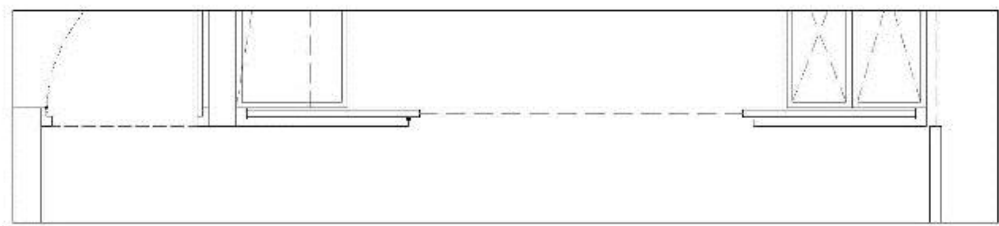

書房拉門平面圖

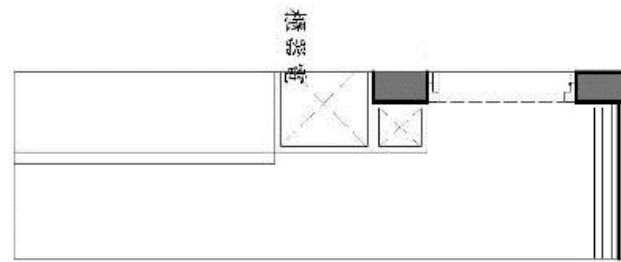

餐廳/客廳平面圖

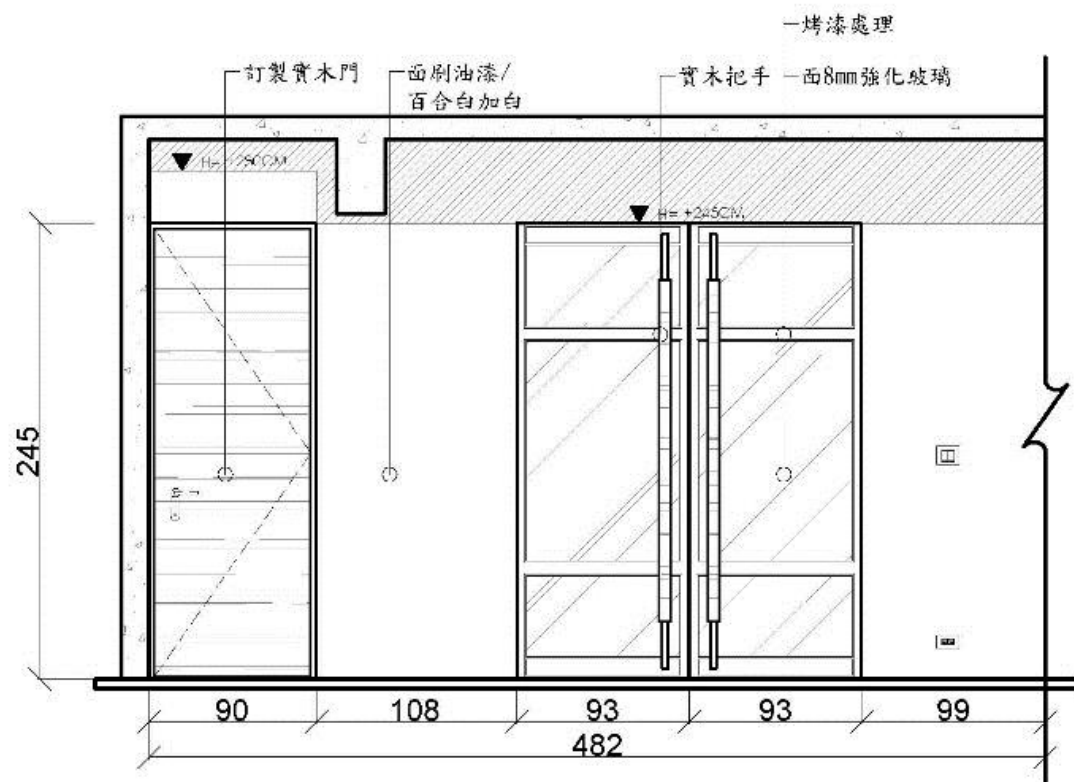

書房拉門立面施工圖

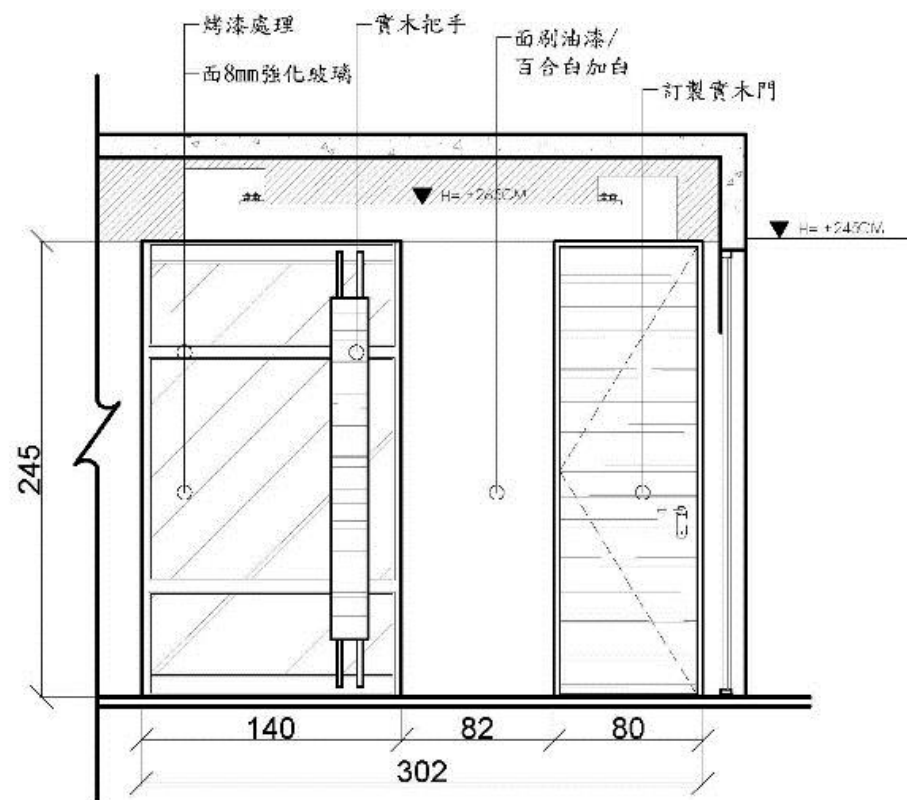

餐廳/客廳立面施工圖

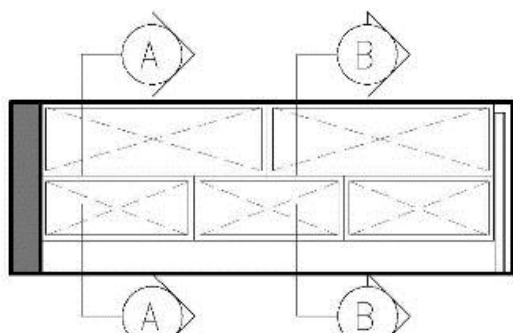

書房書桌平面圖

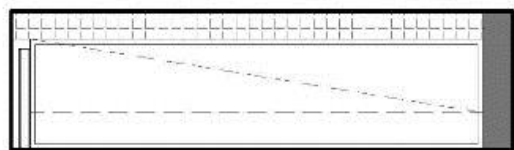

書房書桌平面圖

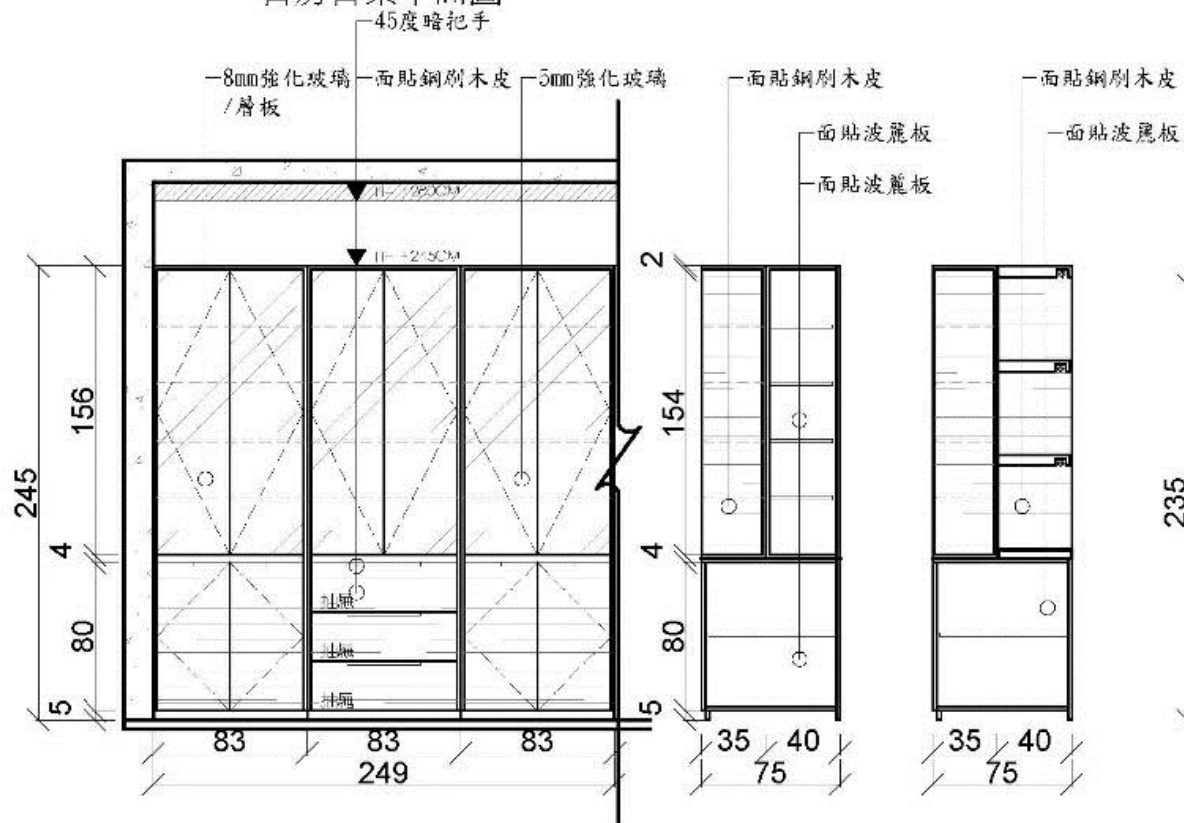

書房書桌立面施工圖

A-A剖面

B-B剖面

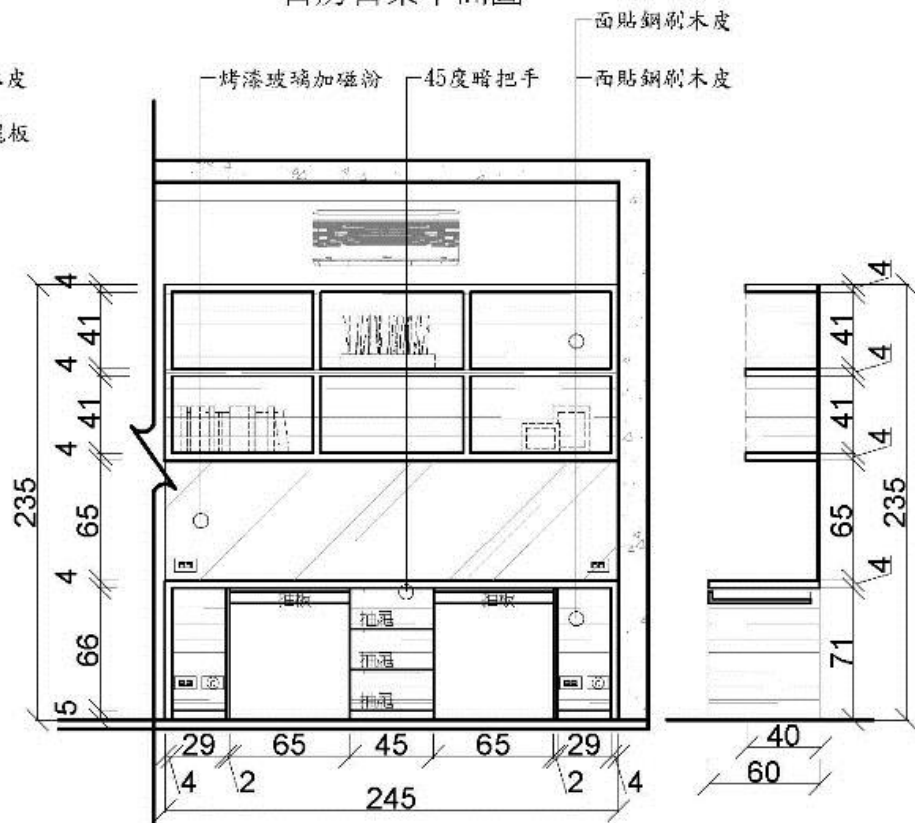

書房書桌立面施工圖



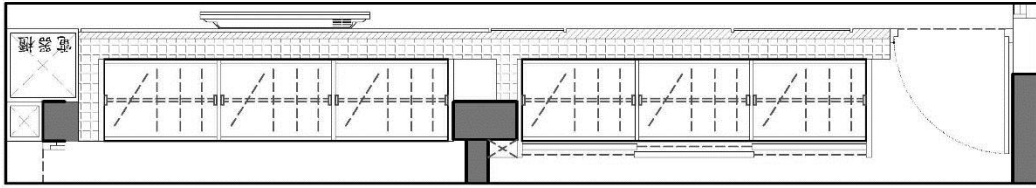

臥室一~二衣櫃面平面圖

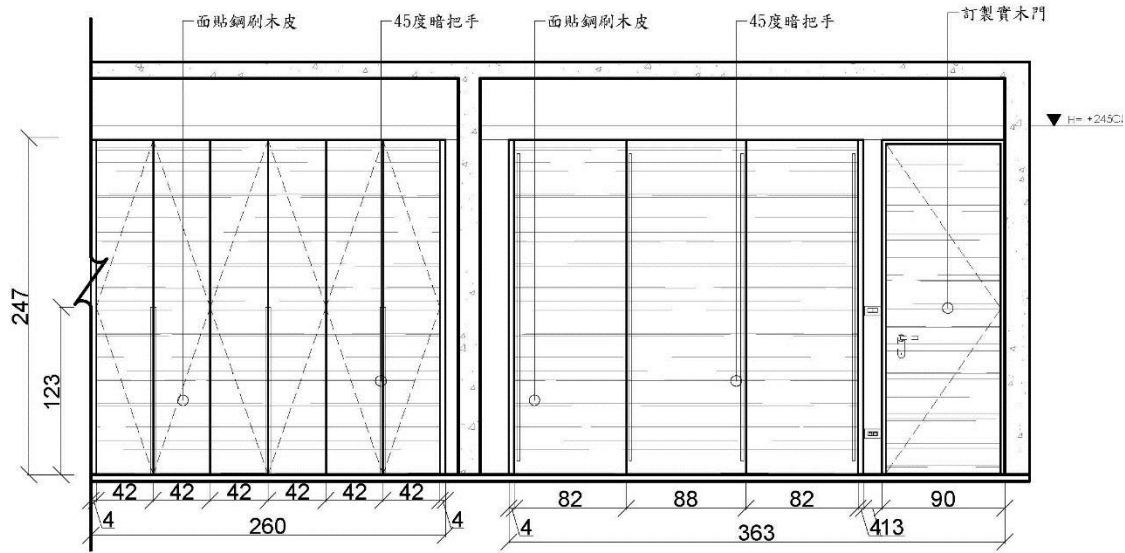

臥室一~二衣櫃面立面施工圖

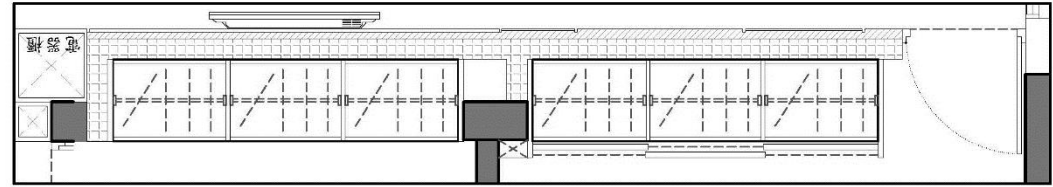

臥室一~二衣櫃面平面圖

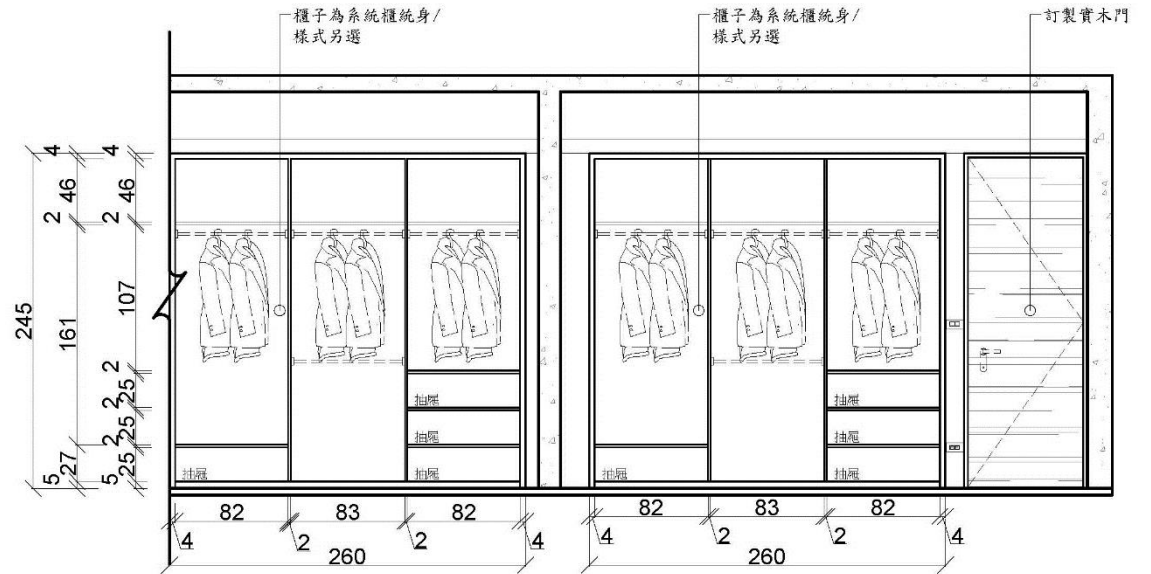

臥室一~二衣櫃面立面施工圖

施工注意事項：  
系統樣式請跟業主確認過才可施工



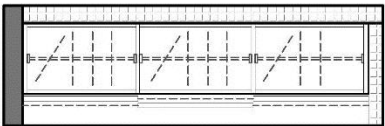

主臥室衣櫃面平面圖

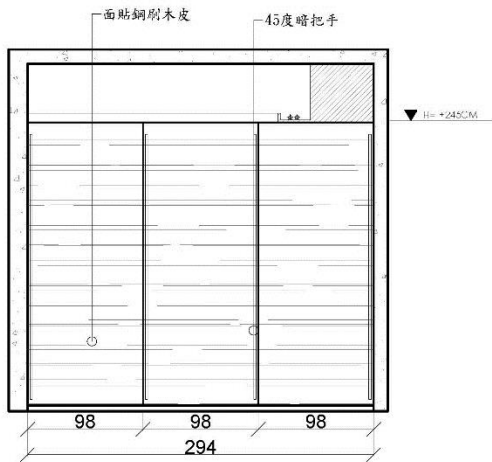

主臥室衣櫃面立面施工圖

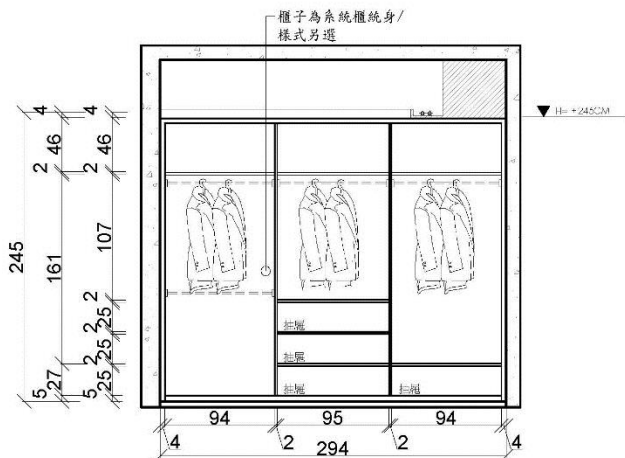

施工注意事項：  
系統樣式請跟業主確認過才可施工

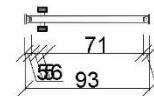
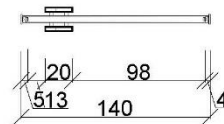

客/餐廳拉門平面圖

書房拉門平面圖

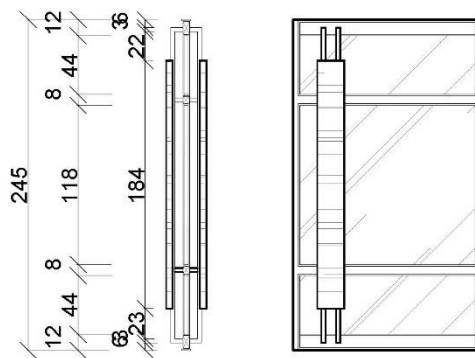

客/餐廳拉門立面施工圖

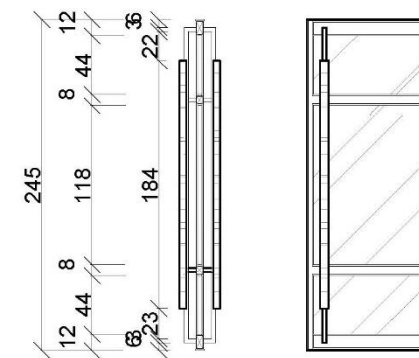

書房拉門立面施工圖