

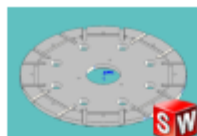

NA-20027-00_A



NA-26016-00_A



NA-10004-00_A



NA-10004-00_B



NA-10005-00_A



NA-10005組合



NA-10006-00_A



NA-10007-00_A



NA-10008-00_A



NA-10009-00_A



NA-10010-00_A



NA-20001



NA-20001-00_A



NA-20002-00_A



NA-20003-00_A



NA-20004-00_C



NA-20004-00_D



NA-20005-00_E



NA-20005-01_E



NA-20006-00_A



NA-20006-01_A



NA-20007-00_A



NA-20008-00_A



NA-20008-01_A



NA-20009-00_A



NA-20009-01_A



NA-20010-00_A



NA-20011-00_A

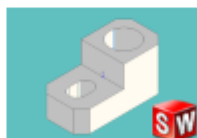

NA-20013-00_A



NA-20016-00_A



NA-20017-00_A



NA-20019-00_A



NA-20020-00_A



NA-20021-00_A



NA-20022-00_A



NA-20028-00_B



NA-20029-00_A



NA-20030-00_A



NA-20031-00_A



NA-20032-00_A

NA-20033-00_A



NA-21002-00_B

NA-20034-00_A



NA-22001-00_A

NA-20034-00_B



NA-22002-00_A

NA-20035-00_A



NA-22003-00_A

NA-20036-00_A



NA-26001-00_A

NA-20037-00_A

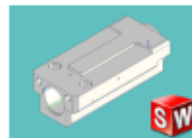

NA-26004-00_A

NA-20037-01_A



NA-26011-00_A

NA-20038-00_A



NA-26012-00_A



NA-26015-02_C



NA-26015-02_D



NA-26017-00_A



NA-26018-00_A

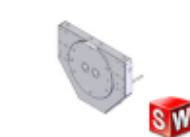

NA-26018-00_C



NA-26019-00_A



NA-26019-00_C



NA-26020-00_A



NA-26021-00_A



NA-26022-00_A



NA-26023-00_A



NA-26023-00_B



NA-26024-00_A



NA-26024-00_B

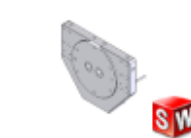

NA-26025-00_A



NA-26026-00_A



NA-26027-00_A



NA-26028-00_A



NA-30001-00_A



NA-30002-00_A



NA-30003-00_A



NA-30004-00_A



NA-30005-00_A



NA-30006-00_A



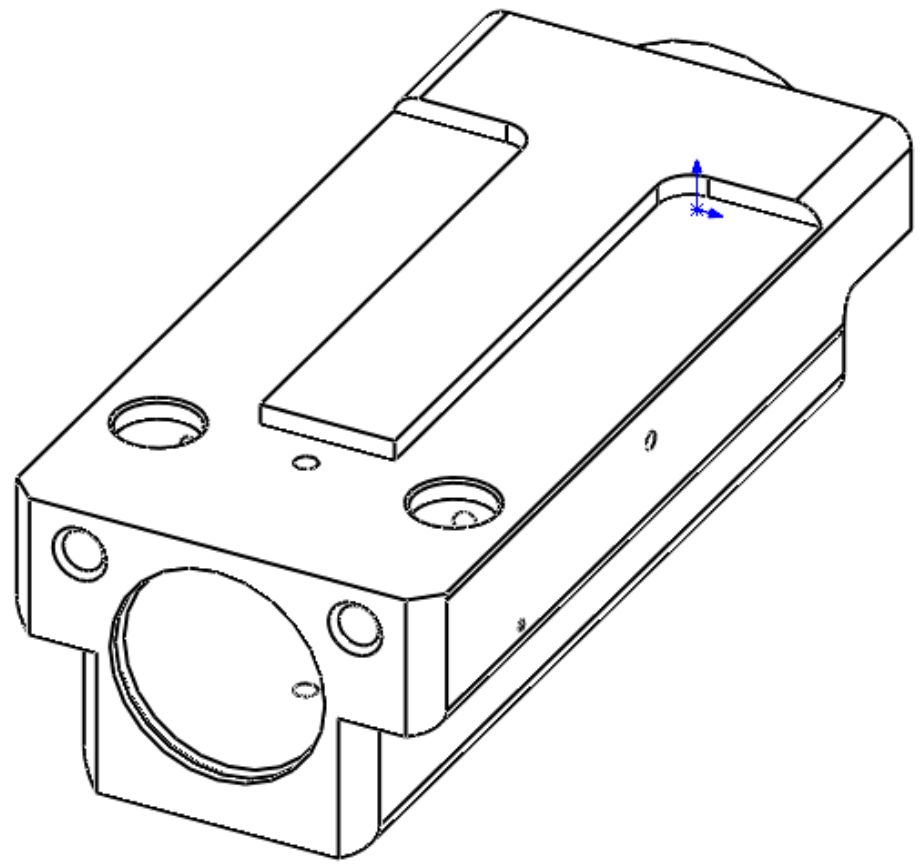
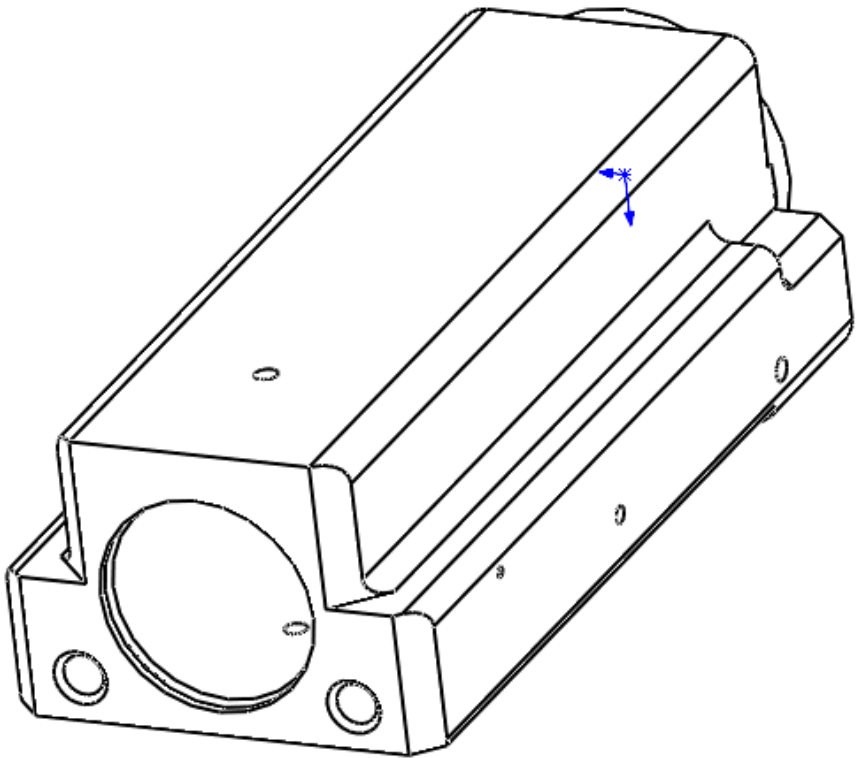

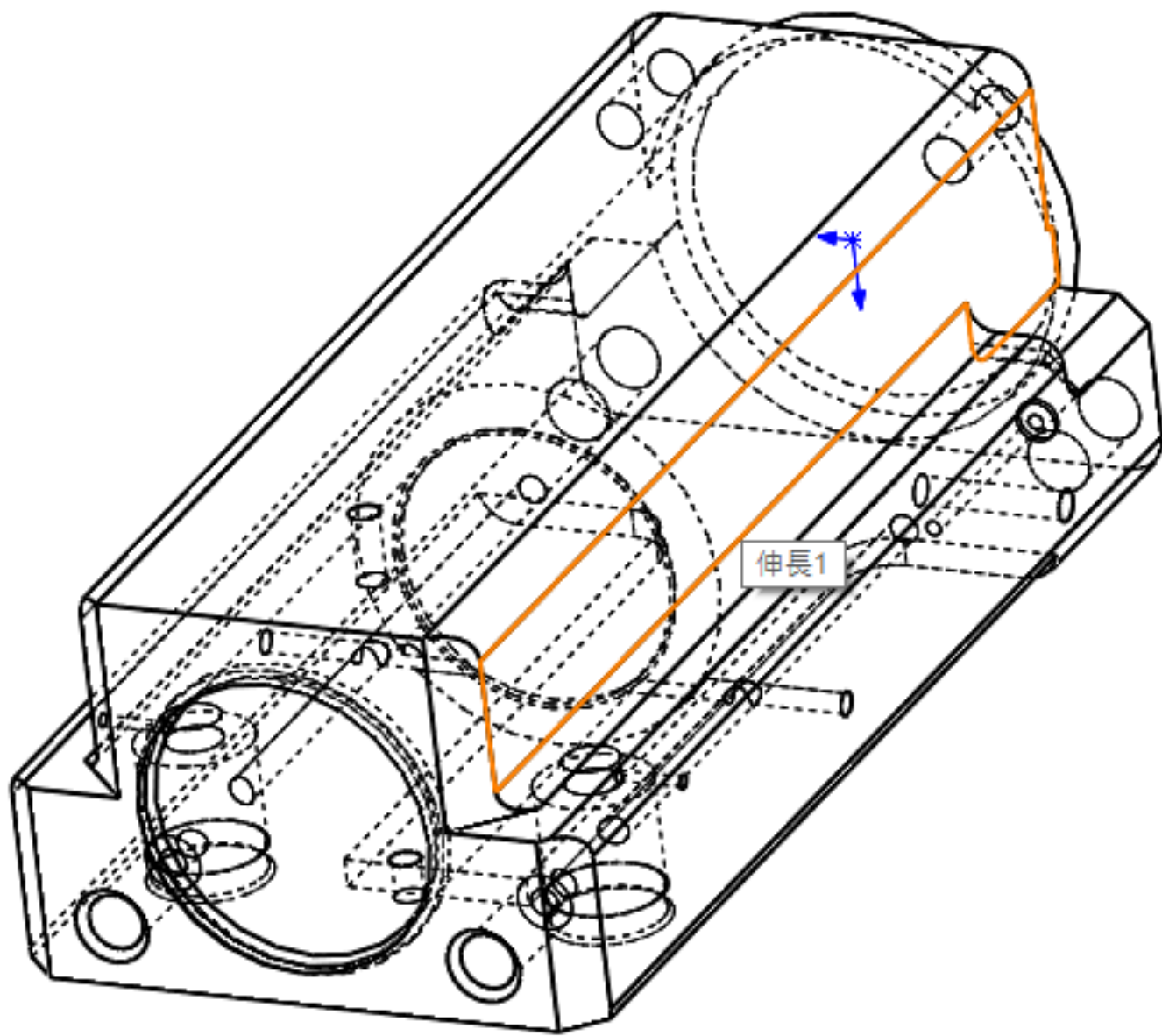

伸長1

NA-21002-00_B

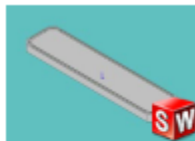

NA-26015-02_C

NA-22001-00_A

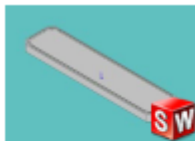

NA-26015-02_D

NA-22002-00_A



NA-26017-00_A

NA-22003-00_A



NA-26018-00_A

NA-26001-00_A

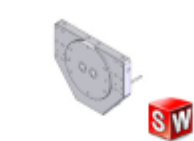

NA-26018-00_C

NA-26004-00_A



NA-26019-00_A

NA-26011-00_A



NA-26019-00_C

NA-26012-00_A



NA-26020-00_A



NA-26021-00_A



NA-26022-00_A



NA-26023-00_A

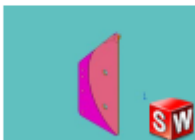

NA-26023-00_B



NA-26024-00_A



NA-26024-00_B

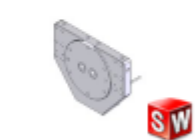

NA-26025-00_A



NA-26026-00_A



NA-26027-00_A



NA-26028-00_A



NA-30001-00_A



NA-30002-00_A



NA-30003-00_A



NA-30004-00_A



NA-30005-00_A



NA-30006-00_A



NA-30009-00_A



NA-30011-00_A



NA-30012-00_A



NA-30013-00_A



NA-30014-00_A



NA-30015-00_A



NA-30017-00_A



NA-30018-00_A



NA-30019-00_A



NA-30020-00_A



NA-30021-00



NA-30021-00_A



NA-35001-00_A



NS-20038-00_A

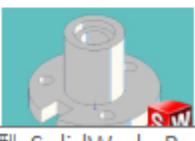

NA-30018-00_A

類型: SolidWorks Part Document
前次存檔者: Gina.Chang

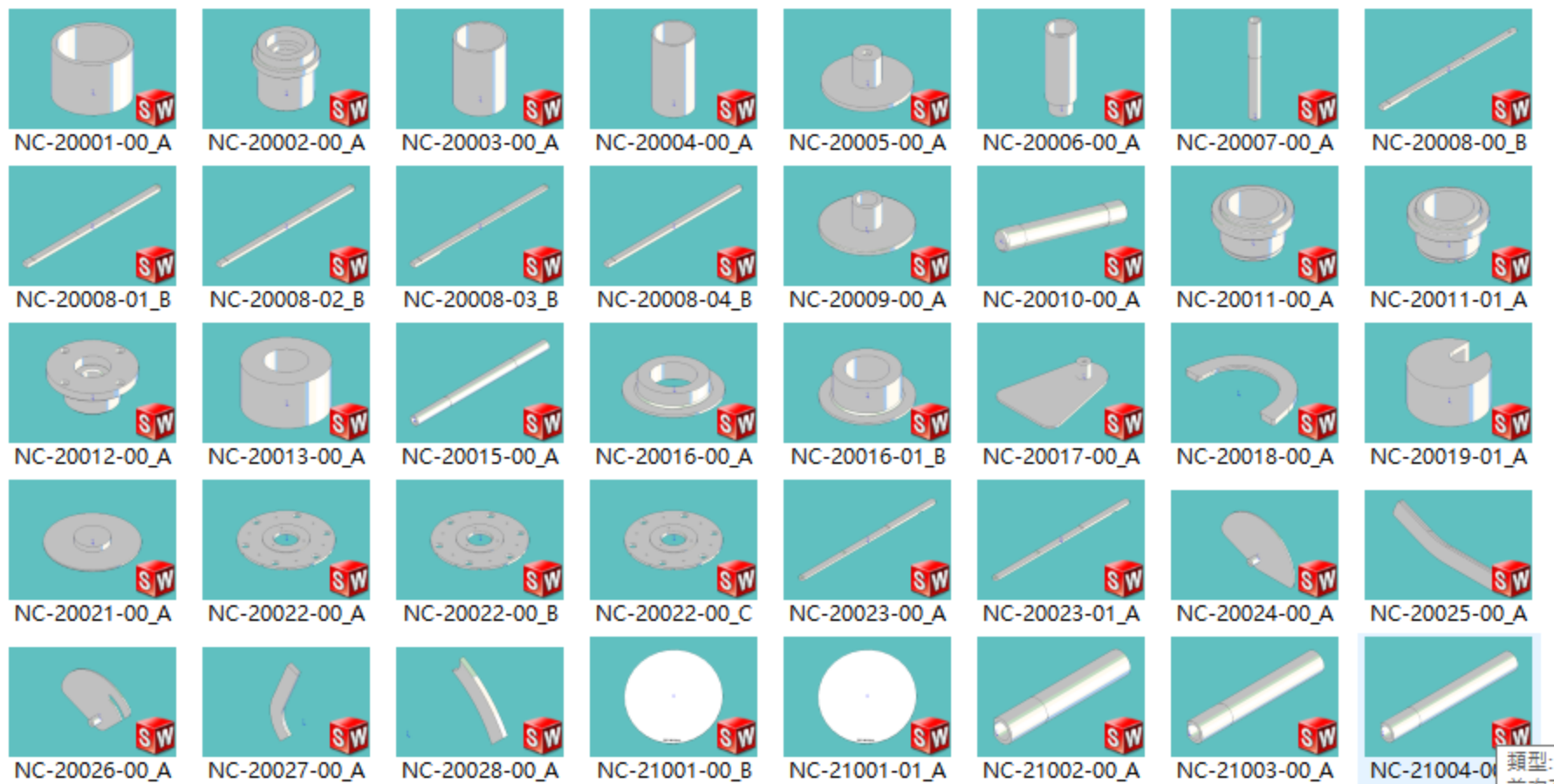

類型:
一一一



NC-20012-00_A



NC-20013-00_A



NC-20015-00_A



NC-20016-00_A



NC-20016-01_B



NC-20017-00_A



NC-20018-00_A



NC-20019-01_A



NC-20021-00_A



NC-20022-00_A



NC-20022-00_B



NC-20022-00_C



NC-20023-00_A



NC-20023-01_A



NC-20024-00_A



NC-20025-00_A



NC-20026-00_A



NC-20027-00_A



NC-20028-00_A



NC-21001-00_B



NC-21001-01_A



NC-21002-00_A



NC-21003-00_A



NC-21004-00_A



NC-21005-00_A



NC-21006-00_A



NC-21011-00_A



NC-21012-00_A



NC-22001-00_A



NC-22002-00_A



NC-22003-00_A



NC-22008-00_A



NC-22009-00_A



NC-26001-03_A



NC-30001-02_A



NC-30001-03_A



NC-30001-04_A



NC-30003-00_A



NC-35001-00_A

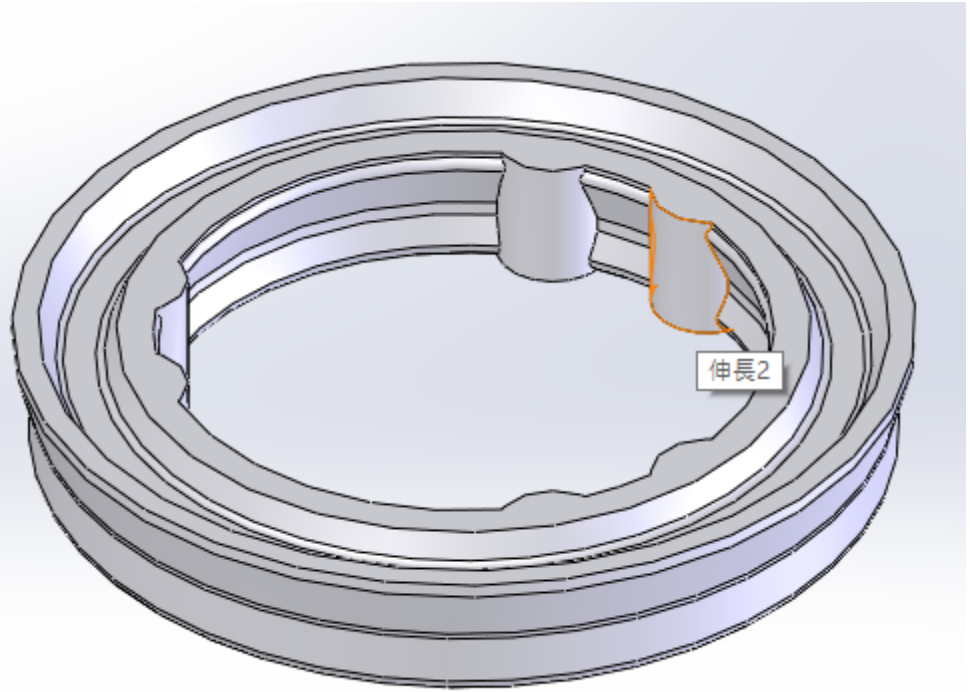
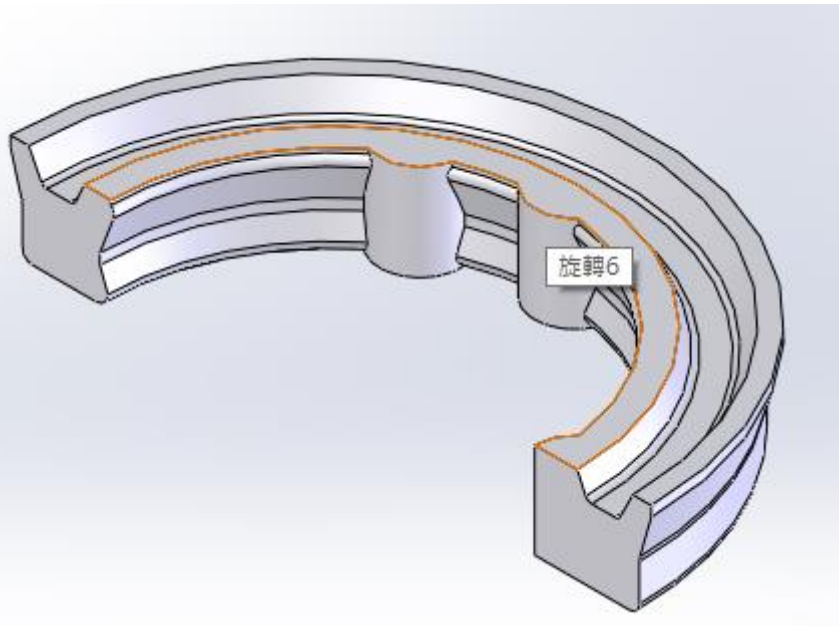

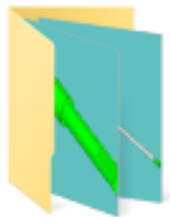

NN-22007-00_A



NN-20001-00_A



NN-20002-00_A



NN-20003-00_A



NN-20005-00_A



NN-20006-00_A



NN-20008-00_A



NN-20009-00_A



NN-20010-00_A



NN-20011-00_A



NN-20012-00_A



NN-20013-00_A



NN-20014-00_A



NN-20015-00_A



NN-20018-00_A



NN-20019-00_A



NN-20020-00_A



NN-20022-00_A



NN-20026-00_A



NN-22001-00_A

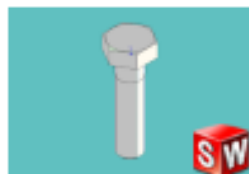

NN-22002-00_A

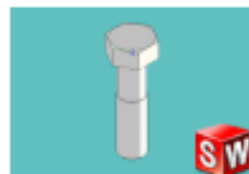

NN-22004-00_A



NN-22005-00_A



NN-22006-00_A



NS-30002-00_B



NS-31001-00_A

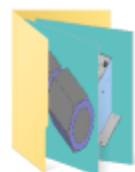

NS-31003-00_B



NS-31004-00_B



NS-32001-00_A



NS-32003-00_A



NS-32004-00_B



NS-32006-00_B



NS-34020-00_A



NS-34031-00_B

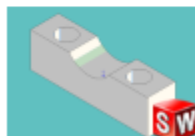

NS-10001-00_A



NS-20011-00_A



NS-20015-00_A



NS-20016-00_H



NS-20016-00_J



NS-20020-00_A



NS-20031-00_A



NS-20032-00_A



NS-20033-00_A



NS-20038-00_B



NS-20039-00_A



NS-20039-00_B



NS-21001-00(1)
_B



NS-21001-00(2)
_B

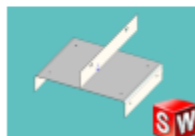

NS-21004-00_A



NS-21005-00_A



NS-22004-00_A



NS-22005-00_A



NS-20039-00_B

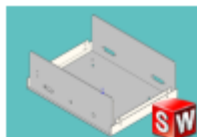

NS-21001-00(1)
_B



NS-21001-00(2)
_B

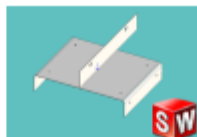

NS-21004-00_A



NS-21005-00_A



NS-22004-00_A



NS-22005-00_A



NS-22006-00_A



NS-22007-00_B



NS-22016-00_A



NS-26017-00_A



NS-26018-00_B



NS-26019-00_A



NS-30001-00_B



NS-30005-00



NS-30005-00_A



NS-30006-00_A



NS-30009-00_A



NS-30018-00_A



NS-31002-00_B



NS-32002-00_A



NS-32005-00_A



NS-34005-00_A



NS-34006-00_A



NS-34007-00_A



NS-34008-00_A



NS-34009-00_A



NS-34010-00_A



NS-34012-00_A



NS-34015-00_A



NS-34016-00_A



NS-34017-00_A



NS-34018-00_A



NS-34021-00_A



NS-34030-00_A



RA-02001-00_A



RA-02001-00_B



RA-02002-00_A



RA-02003-00_A



RA-02005-00_B



RA-02005-00_C



RA-02005-00_D



RA-02006-00_B



RA-02006-00_C

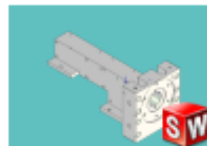

RA-02006-00_D



RA-02007-00



RA-02007-00_A



RA-02007-00_B



RA-03001-00_A



RA-03002-00_A



RA-03002-00_B



RA-03003-00_A



RA-03003-00_B



RA-03004-00_A



RA-03004-00_B



RA-03004-00_C



RA-03004-00_D



RA-03005-00_A



RA-03005-00_B



RA-06001-00_A



RA-06002-00_A



RA-06003-00_A



RA-06004-00_B



RA-03004-00_D



RA-03005-00_A



RA-03005-00_B



RA-06001-00_A



RA-06002-00_A



RA-06003-00_A



RA-06004-00_B



RA-06004-00_C

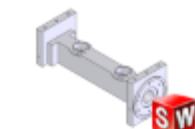

RA-06004-00_D

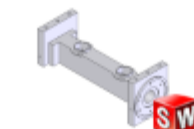

RA-06004-00_E



RA-06005-00_A



RA-06005-00_B



RA-06006-00_A



RA-06006-00_B



RA-06006-00_C

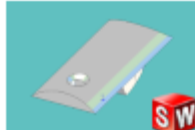

RA-06007-00_A

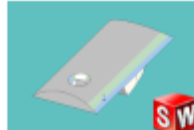

RA-06007-00_B

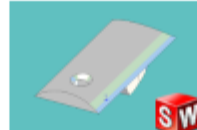

RA-06007-00_C



RA-08001-00_B



RA-08001-00_C

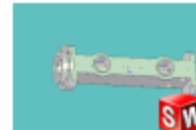

RA-08001-00_D



RA-08001-00_E



RA-22001-00_A

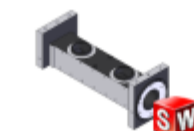

RA-22001-00_B

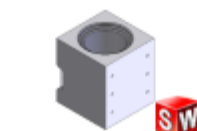

RA-22002-00_A



RA-N1002-00_A

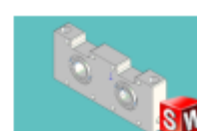

RA-N1003-00_A



RA-N1004-00_A



RA-N1005-00_A



RA-N1006-00_A



RF-02001-00_A



RF-02002-00_A



RF-03001-00_B



RF-03002-00_A



RF-06001-00_B



RF-06002-00_B

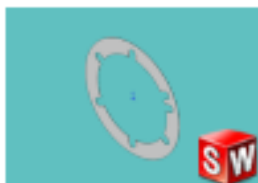

RF-06003-00_B



RF-06004-00_A



RF-06005-00_A



RF-06006-00_B



RF-06007-00_A



RF-06008-00_A



RF-06009-00_A



RF-22001-00_A



RF-A8002-00_A



RF-A8002-00_B



XX-00007-04_A



XX-00008-00_A

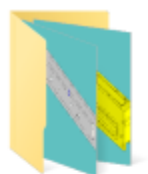

XX-00008-01_A



XX-00038-07_A



XX-00038-08_A



XX-00041-07_A



XX-00001-00_A



XX-00001-01_A

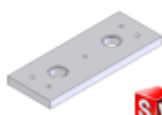

XX-00002-00_A

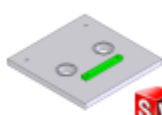

XX-00002-01_A

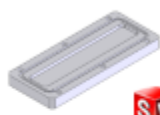

XX-00003-00_A

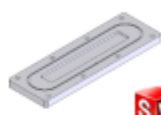

XX-00004-00_A



XX-00004-01_A



XX-00004-02_A



XX-00004-03_A

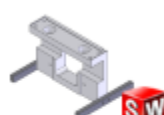

XX-00005-00_A



XX-00006-00_A



XX-00006-01_A

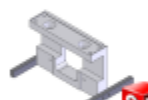

XX-00007-00_B(1)



XX-00007-00_B(2)

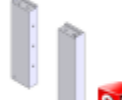

XX-00007-01_A(1)



XX-00007-01_A(2)

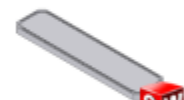

XX-00007-02_A



XX-00007-03_A

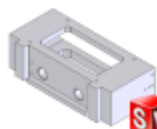

XX-00007-07_A



XX-00007-08_A



XX-00007-09_A

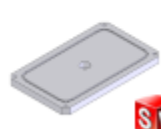

XX-00007-10_A



XX-00007-11_A

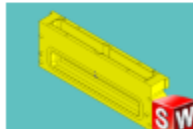

XX-00008-02_A

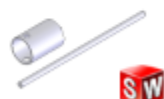

XX-00008-03_A



XX-00008-04_A

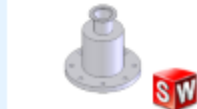
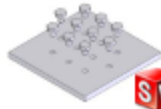



XX-00012-02_A



XX-00012-03_A



XX-00012-04_A

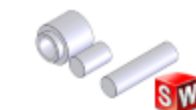

XX-00013-00_A

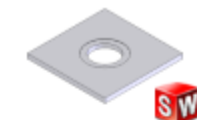

XX-00013-02_A



XX-00013-03_A



XX-00013-04_B

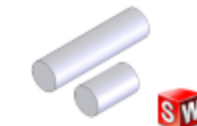

XX-00013-05_A



XX-00013-06_A



XX-00015-00_A

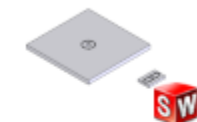

XX-00016-00_A



XX-00017-00_A

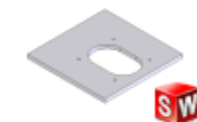

XX-00017-01_A

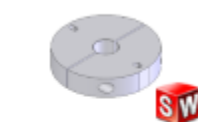

XX-00018-00_A



XX-00019-00_A

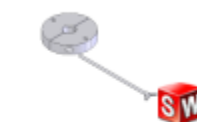

XX-00020-00_A

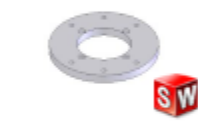

XX-00020-01_A



XX-00020-02_A



XX-00021-00_A

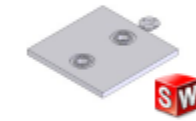

XX-00022-00_A

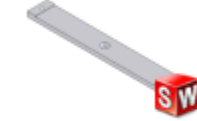

XX-00022-01_A

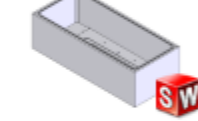

XX-00022-02_A



XX-00022-03_A

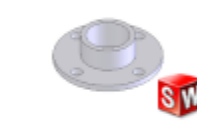

XX-00022-04_A



XX-00022-05_A

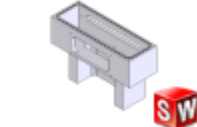

XX-00022-06_A

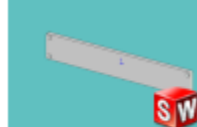

XX-00022-07_A

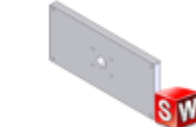

XX-00022-08_A

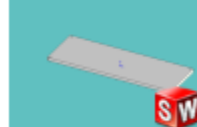

XX-00022-09_A



XX-00023-00_A



XX-00023-01_A

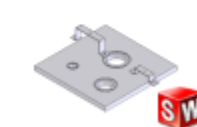

XX-00024-00_A

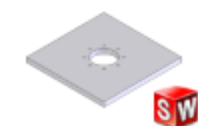

XX-00025-00_A



XX-00026-00_A

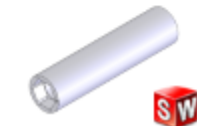

XX-00027-00_A

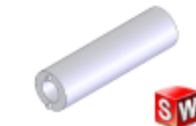

XX-00027-01_A



XX-00028-00_A



XX-00029-00_A

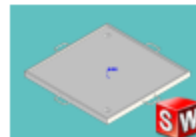

XX-00030-00_A(

1)



XX-00030-00_A(

3)

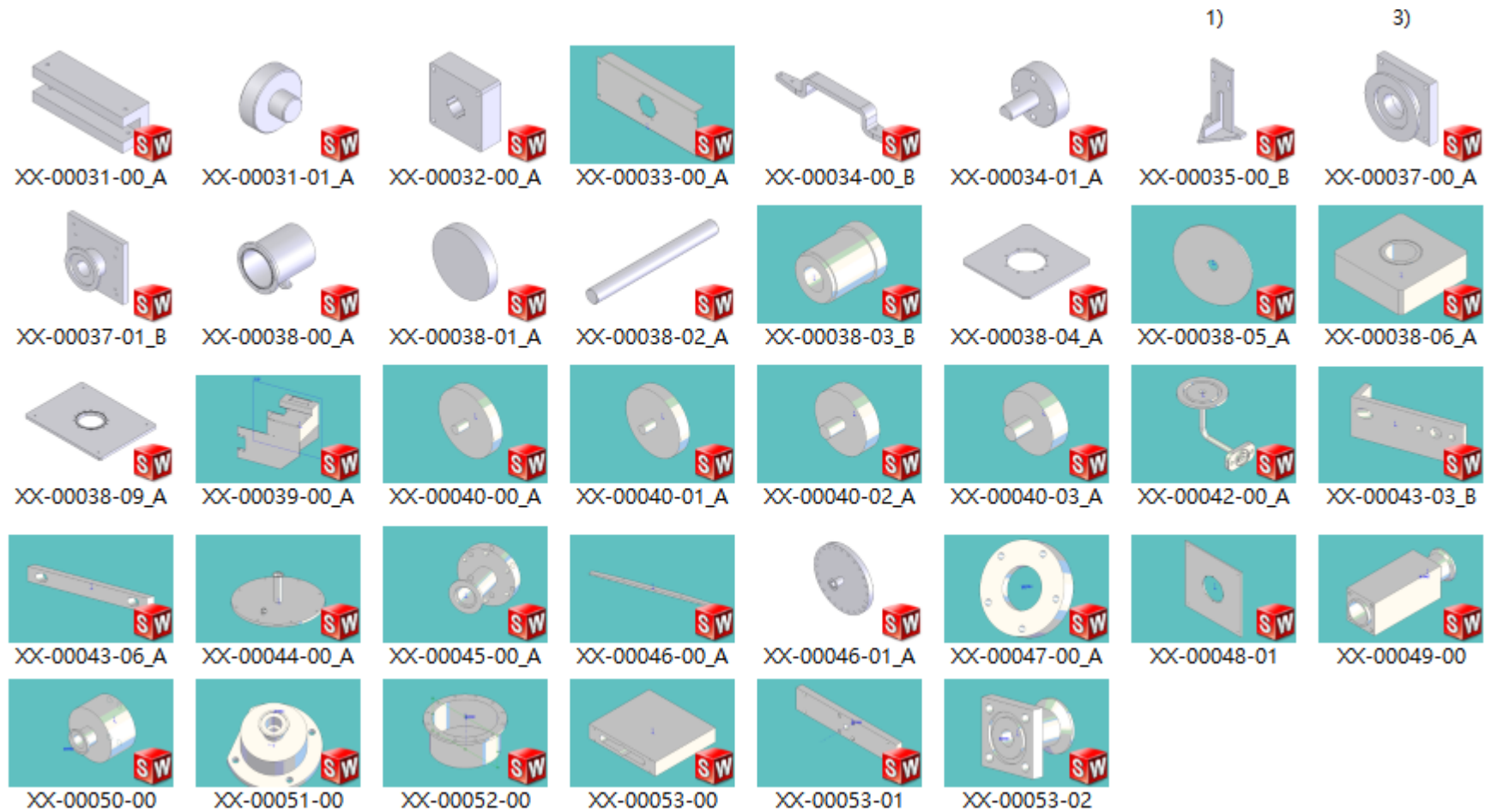

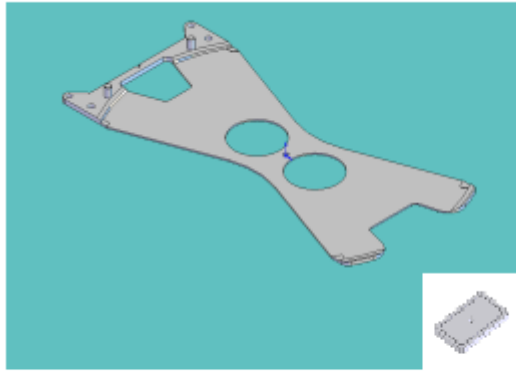

AQ-20001-00_A

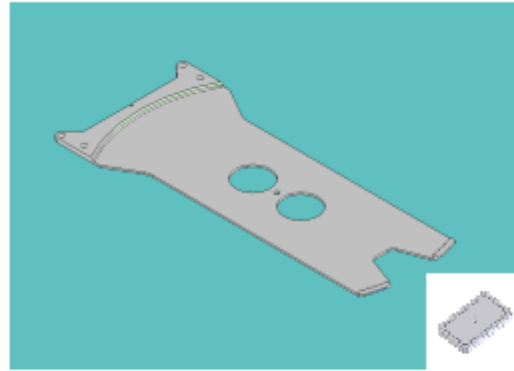

AQ-20001-02_A

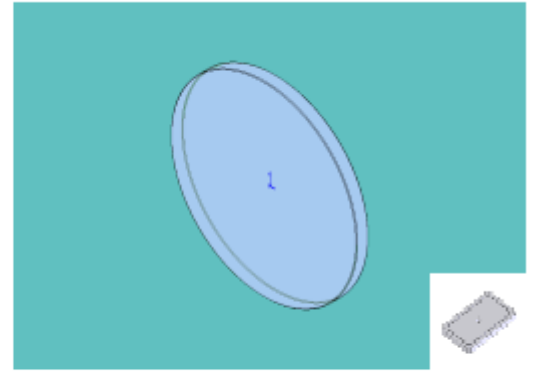

AQ-24001-00_A



AS-34012-00_A



AS-36001-00_A



AS-20001-00_A



AS-20002-00_A



AS-20003-00_A



AS-20004-00_A



AS-20004-01_A



AS-20005-00_A



AS-20006-00



AS-20007-00_A



AS-20009-00_A



AS-21002-00_B



AS-21003-00_A



AS-21003-02_A



AS-21006-00_A



AS-21007-00_A



AS-21007-02_A



AS-21009-00_A



AS-21010-00_A



AS-21012-00_A



AS-21013-00_A



AS-21014-00_A

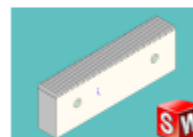

AS-21015-00_A



AS-21020-00_A



AS-21022-00_A



AS-21027-00_A



AS-21027-00_B



AS-21027-00_C



AS-21028-00_A



AS-21030-00_A



AS-21034-00_A



AS-21035-00_A



AS-21036-00_A



AS-21037-00_A



AS-21038-00_A



AS-21039-00_A



AS-21040-00_A

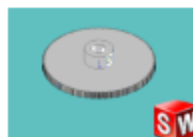

AS-21041-00_A



AS-21042-00_A



AS-21043-00_A



AS-21043-00_B



AS-21044-00_A

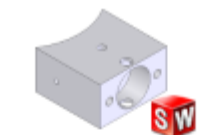

AS-21045-00_A

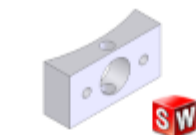

AS-21046-00_A

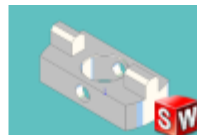

AS-22002-00_A



AS-22003-00_A



AS-22004-00_B



AS-22005-00_A



AS-22005-00_B



AS-22006-00_A



AS-22006-00_B



AS-24002-00_A



AS-24002-00_B



AS-24002-00_C

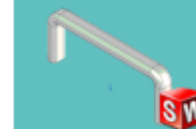

AS-24003-00_A



AS-30007-00_A



AS-31001-00_A



AS-33001-00_A



AS-33004-00_A



AS-33004-00_B

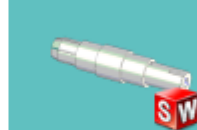

AS-33006-00_A



AS-33006-00_B



AS-34001-00_A

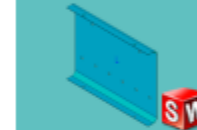

AS-34004-00_A

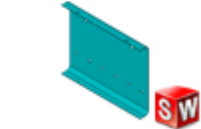

AS-34004-00_B



AS-34005-00_A



AS-34005-00_B



AS-34006-00_A



AS-34006-00_B



AS-34008-00_A



AS-34008-01_A



AS-34015-00_A



AS-34016-00_B

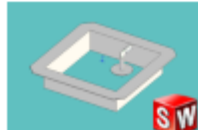

AS-36002-00_A



AS-36003-00_A



AS-36004-00_A



AS-2100402-01



AS-2100402-02

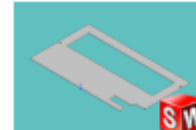

AS-2100502-01



AS-2101600-01



AT-20002-00_A



AT-20003-00_B



AT-20004-00_A



AT-20005-00_A



AT-21002-00_A



AT-21003-00_B



AT-22001-00_C



AT-22002-00_D



AT-22003-00_A